



HR

Posjedujemo jednu od najsuvremenijih linija za emajliranje dimovodnih cijevi u Europi.

Radimo s tekućim i s praškastim emajlom, a u ponudi imamo široku paletu boja u mat ili sjajnoj verziji te time zadovoljavamo potrebe svih kupaca. Emajlirani dimovodni elementi izrađeni su od čeličnog lima na čiju je površinu nanesen sloj staklastog emajla. Odlikuju se povećanom otpornošću na koroziju i estetskim izgledom. Imaju toplinsku otpornost do 600 °C.

ENG

We have one of the most modern enameling lines for flue pipes in Europe.

We work with liquid and powder enamel, in a wide range of colours, both matte and glossy to satisfy the needs of all our customers. Enamel flue elements are made of steel sheets whose surface is covered with a layer of glass enamel. They are distinguished by their increased resistance to corrosion and aesthetic appearance. They are heat resistant up to 600 °C.

DE

Wir haben eine der modernsten Linien für die Emallierung von Rohren in Europa.

Wir arbeiten mit Flüssig- sowohl aber auch mit Pulveremalle und bieten eine breite Palette von Farben in der Matt- oder Glanzausführung an und erfüllen so die Bedürfnisse aller Kunden. Die emallierten Rauchrohrelemente bestehen aus Stahlblech, auf dessen Oberfläche eine glasartige Emailschiicht aufgebracht ist. Sie zeichnen sich durch erhöhte Korrosionsbeständigkeit und ein ästhetisches Erscheinungsbild aus. Sie haben eine Wärmebeständigkeit von bis zu 600 °C.

0,40 mm | 0,60 mm | 1,20 mm



**Emajlirani dimovodni
program – čelični lim**

**Enamel program of steel
sheet flue elements**

**Rauchrohrprogramm mit
emaillierten Rauchrohren
- Stahlblech**

COLOR

 **0,40 mm** Čelični lim / Steel sheet / Stahlblech

● ● ○ Boje: crna, smeđa i bijela / Color: black, brown and white / Farbe: schwarz, braun und weiß

Koljeno 90° / Elbow 90° / Rauchrohrbogen, 90°

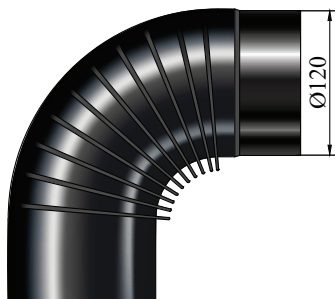

BROJ ARTIKLA
ART. NR.
CODE

ECE01-120

Dimovodna cijev / Flue pipe / Rauchrohr

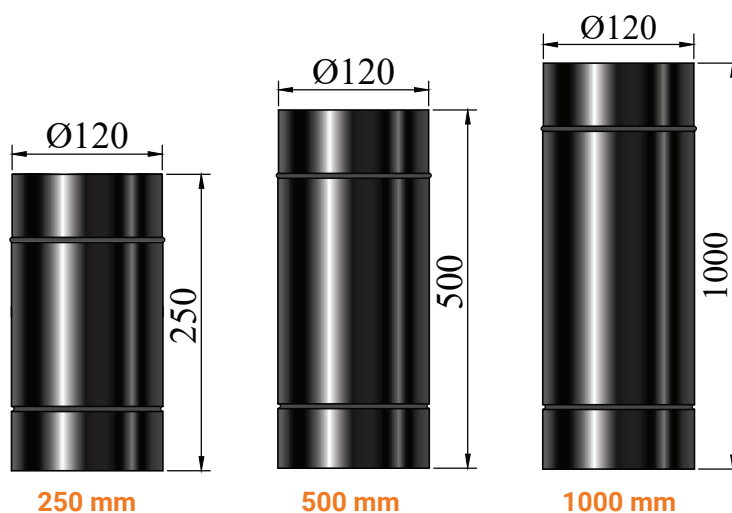

250 mm	
Ø [mm]	BROJ ARTIKLA ART. NR. CODE
120	ECE04-120

500 mm	
Ø [mm]	BROJ ARTIKLA ART. NR. CODE
120	ECE03-120

1000 mm	
Ø [mm]	BROJ ARTIKLA ART. NR. CODE
120	ECE02-120

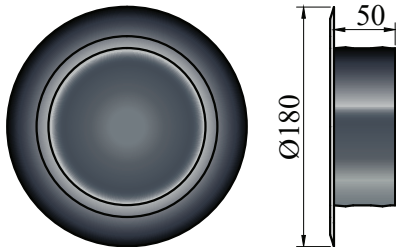

 **Rozeta s poklopcem / Rosette collar with cover**
/ Rosette mit Deckel



BROJ ARTIKLA
ART. NR.
CODE

ECE05-120

BOJE / COLOR / FARBE

-  Bijela / White / Weiss
-  Smeđa / Brown / Braun
-  Crna / Black / Schwarz



0,60 mm Čelični lim / Steel sheet / Stahlblech



Boje: crna, smeđa i bijela / Color: black, brown and white / Farbe: schwarz, braun und weiß

Koljeno 90° / Elbow 90° / Rauchrohrbogen, 90°

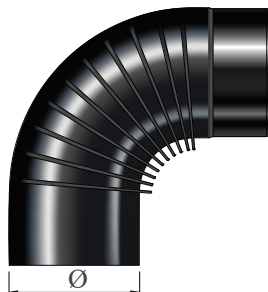

90°

Ø [mm]	BROJ ARTIKLA ART. NR. CODE
100	ECE07-100
110	ECE07-110
120	ECE07-120
130	ECE07-130
150	ECE07-150
180	ECE07-180
200	ECE07-200

45°

Ø [mm]	BROJ ARTIKLA ART. NR. CODE
100	ECE08-100
110	ECE08-110
120	ECE08-120
130	ECE08-130
150	ECE08-150
180	ECE08-180
200	ECE08-200

Dimovodna cijev / Flue pipe / Rauchrohr

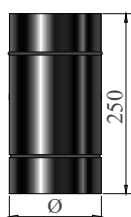

A

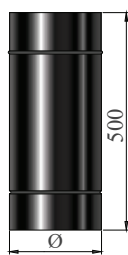

B

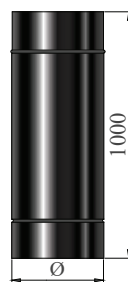

C

A 250 mm

Ø [mm]	BROJ ARTIKLA ART. NR. CODE
100	ECE10-100
110	ECE10-110
120	ECE10-120
130	ECE10-130
150	ECE10-150
180	ECE10-180
200	ECE10-200

B 500 mm

Ø [mm]	BROJ ARTIKLA ART. NR. CODE
100	ECE09-100
110	ECE09-110
120	ECE09-120
130	ECE09-130
150	ECE09-150
180	ECE09-180
200	ECE09-200

C 1000 mm

Ø [mm]	BROJ ARTIKLA ART. NR. CODE
100	ECE11-100
110	ECE11-110
120	ECE11-120
130	ECE11-130
150	ECE11-150
180	ECE11-180
200	ECE11-200

► **T komad / Tee / T Stück**

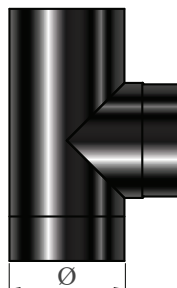

**S poklopcem / With cover /
Mit Deckel**

Ø [mm]	BROJ ARTIKLA ART. NR. CODE
120	ECE12-120
130	ECE12-130
150	ECE12-150
180	ECE12-180
200	ECE12-200

► **Cijev s kondenzacijskim prstenom / Flue pipe with condensate ring
/ Rauchrohr mit Kondensring**

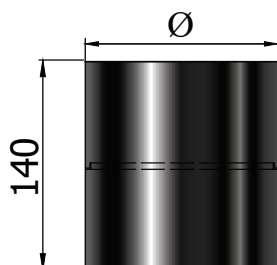

Ø [mm]	BROJ ARTIKLA ART. NR. CODE
130	ECE13-130
150	ECE13-150

ADAPTER (redukcija) 0,6 mm emajlirana
 ADAPTER (Reduktion) 0,6 mm emailliert
 ADAPTER (Reducing pipe fitting) 0,6 mm enamel

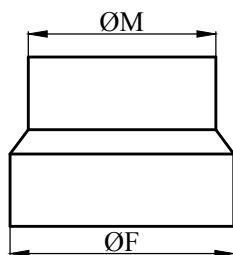

ØF/ØM [mm]	Broj artikla Art.Nr. Code
110/100	ECE14-001
120/100	ECE14-002
120/110	ECE14-003
130/120	ECE14-004
130/110	ECE14-005
130/100	ECE14-006
150/130	ECE14-007
150/120	ECE14-008
180/150	ECE14-009
200/180	ECE14-010

big diameter female/small diameter male

ADAPTER (proširenje) 0,6 mm emajlirano
 ADAPTER (Erweiterung) 0,6 mm emailliert
 ADAPTER (Extension) 0,6 mm enamel

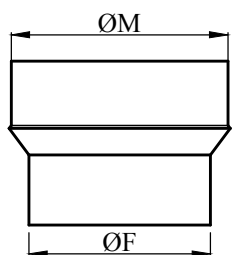

ØF/ØM [mm]	Broj artikla Art.Nr. Code
100/110	ECE15-001
100/120	ECE15-002
110/120	ECE15-003
120/130	ECE15-004
110/130	ECE15-005
100/130	ECE15-006
130/150	ECE15-007
120/150	ECE15-008
150/180	ECE15-009
180/200	ECE15-010

small diameter female/big diameter male

ROZETA emajlirana
 ROSETTE emailliert
 ROSE CAP enamel

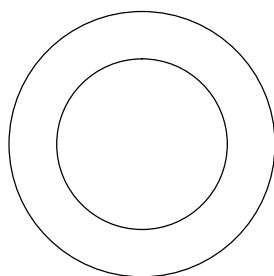

Ø [mm]	Broj artikla Art.Nr. Code
100	ECE16-100
110	ECE16-110
120	ECE16-120
130	ECE16-130
150	ECE16-150
180	ECE16-180
200	ECE16-200

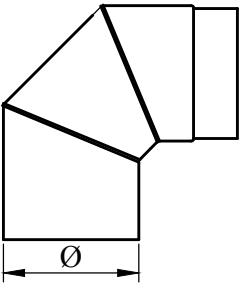
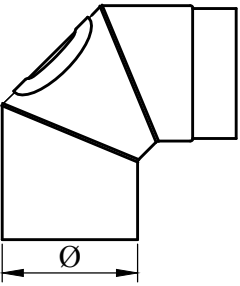
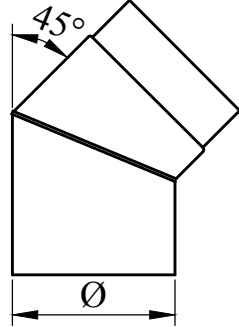
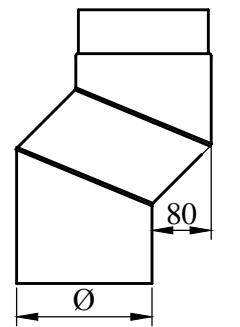
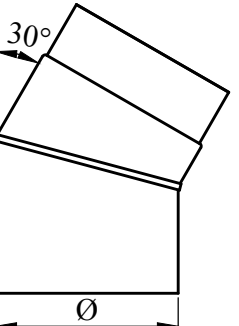
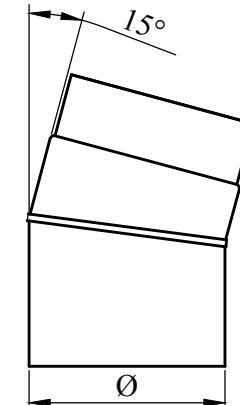
Koljeno 90°x0,6 trodijelno emajlirano Rauchrohrbogen 90°x0,6 3-teilig emailliert Elbow 90°x0,6 3-part enamel				Koljeno 90°x0,6 trodijelno s otvorom emajlirano Rauchrohrbogen 90°x0,6 3-teilig mit Tür emailliert Elbow 90°x0,6 3-part with door enamel					
	Ø	Broj artikla	kom./pal.		Ø	Broj artikla	kom./pal.		
	[mm]	Art.Nr.	stück/pal.		[mm]	Art.Nr.	stück/pal.		
		Code	pcs./pal.			Code	pcs./pal.		
		120	CEE019-120		112		120	CEE020-120	112
		125	CEE019-125		112		125	CEE020-125	112
		130	CEE019-130		112		130	CEE020-130	112
		140	CEE019-140		112		140	CEE020-140	112
		150	CEE019-150		112		150	CEE020-150	112
		160	CEE019-160		100		160	CEE020-160	100
	180	CEE019-180	60		180	CEE020-180	60		
	200	CEE019-200	54		200	CEE020-200	54		
Koljeno 45°x0,6 dvodijelno emajlirano Rauchrohrbogen 45°x0,6 2-teilig emailliert Elbow 45°x0,6 2-part enamel				S-Koljeno 80x0,6 emajlirano S-Rauchrohrbogen 80x0,6 emailliert S-Elbow 80x0,6 enamel					
	Ø	Broj artikla	kom./pal.		Ø	Broj artikla	kom./pal.		
	[mm]	Art.Nr.	stück/pal.		[mm]	Art.Nr.	stück/pal.		
		Code	pcs./pal.			Code	pcs./pal.		
		120	CEE027-120		144		120	CEE110-120	112
		125	CEE027-125		144		125	CEE110-125	112
		130	CEE027-130		144		130	CEE110-130	112
		140	CEE027-140		126		140	CEE110-140	112
		150	CEE027-150		126		150	CEE110-150	112
		160	CEE027-160		108		160	CEE110-160	100
	180	CEE027-180	84		180	CEE110-180	60		
	200	CEE027-200	60		200	CEE110-200	54		
Koljeno 30°x0,6 dvodijelno emajlirano Rauchrohrbogen 30°x0,6 2-teilig emailliert Elbow 30°x0,6 2-part enamel				Koljeno 15°x0,6 dvodijelno emajlirano Rauchrohrbogen 15°x0,6 2-teilig emailliert Elbow 15°x0,6 2-part enamel					
	Ø	Broj artikla	kom./pal.		Ø	Broj artikla	kom./pal.		
	[mm]	Art.Nr.	stück/pal.		[mm]	Art.Nr.	stück/pal.		
		Code	pcs./pal.			Code	pcs./pal.		
		120	CEE026-120		144		120	CEE024-120	144
		125	CEE026-125		144		125	CEE024-125	144
		130	CEE026-130		144		130	CEE024-130	144
		140	CEE026-140		126		140	CEE024-140	126
		150	CEE026-150		126		150	CEE024-150	126
		160	CEE026-160		108		160	CEE024-160	108
	180	CEE026-180	84		180	CEE024-180	84		
	200	CEE026-200	60		200	CEE024-200	60		

T600 N1 D Vm L80060 GXXX NM

Color emajl



1,20 mm Čelični lim / Steel sheet / Stahlblech



Boje: crna, smeđa i bijela / Color: black, brown and white / Farbe: schwarz, braun und weiß

Dimovodna cijev / Flue pipe / Rauchrohr

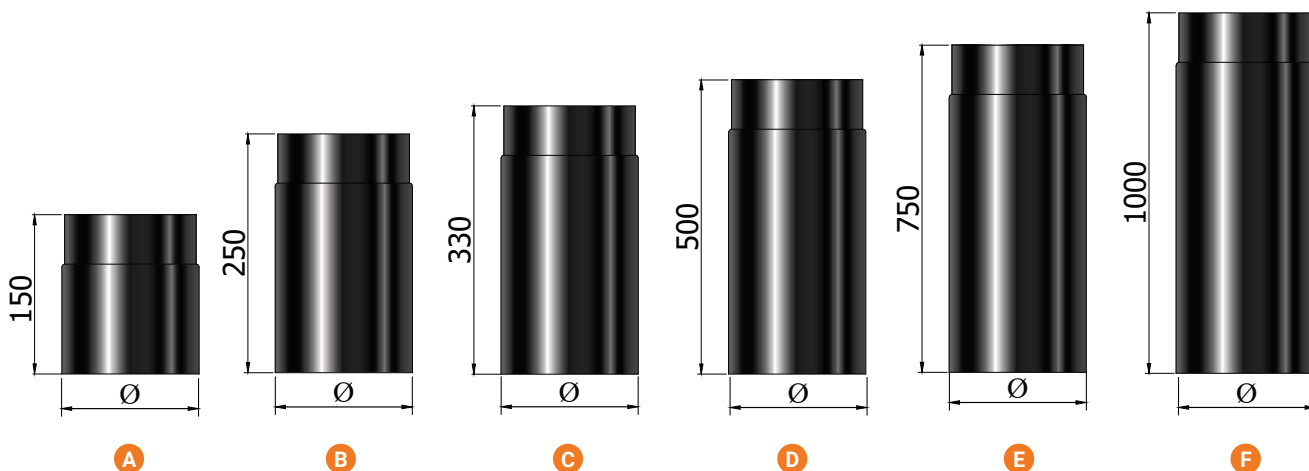

A 150

Ø [mm]	BROJ ARTIKLA ART. NR. CODE	KOM./PAL. PCS./PAL. STÜCK/PAL.
120	CE037E-120	280
125	CE037E-125	280
130	CE037E-130	280
150	CE037E-150	280
160	CE037E-160	240
180	CE037E-180	240
200	CE037E-200	165

B 250

Ø [mm]	BROJ ARTIKLA ART. NR. CODE	KOM./PAL. PCS./PAL. STÜCK/PAL.
120	CE004E-120	288
125	CE004E-125	288
130	CE004E-130	288
140	CE004E-140	210
150	CE004E-150	210
160	CE004E-160	180
180	CE004E-180	162
200	CE004E-200	120

C 330

Ø [mm]	BROJ ARTIKLA ART. NR. CODE	KOM./PAL. PCS./PAL. STÜCK/PAL.
120	CE050E-120	144
125	CE050E-125	144
130	CE050E-130	144
150	CE050E-150	154 (175)
160	CE050E-160	154
180	CE050E-180	120
200	CE050E-200	56

D 500

Ø [mm]	BROJ ARTIKLA ART. NR. CODE	KOM./PAL. PCS./PAL. STÜCK/PAL.
120	CE003E-120	144
125	CE003E-125	144
130	CE003E-130	144
140	CE003E-140	105
150	CE003E-150	105
160	CE003E-160	80
180	CE003E-180	72
200	CE003E-200	56

E 750

Ø [mm]	BROJ ARTIKLA ART. NR. CODE	KOM./PAL. PCS./PAL. STÜCK/PAL.
120	CE033E-120	65
125	CE033E-125	65
130	CE033E-130	65
150	CE033E-150	70
160	CE033E-160	70
180	CE033E-180	40
200	CE033E-200	27

F 1000

Ø [mm]	BROJ ARTIKLA ART. NR. CODE	KOM./PAL. PCS./PAL. STÜCK/PAL.
120	CE002E-120	65
125	CE002E-125	65
130	CE002E-130	65
140	CE002E-140	55
150	CE002E-150	55
160	CE002E-160	40
180	CE002E-180	40
200	CE002E-200	27

Koljeno trodijelno 90° / Elbow 3-part 90° / Dreiteiliger Rauchrohrbogen, 90°

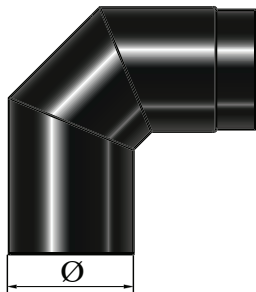

A



B

A

Ø [mm]	BROJ ARTIKLA ART. NR. CODE	KOM./PAL. PCS./PAL. STÜCK/PAL.
120	CE005E-120	98
125	CE005E-125	98
130	CE005E-130	98
140	CE005E-140	98
150	CE005E-150	98
160	CE005E-160	85
180	CE005E-180	54
200	CE005E-200	48

B S otvorom / With door / Mit tür

Ø [mm]	BROJ ARTIKLA ART. NR. CODE	KOM./PAL. PCS./PAL. STÜCK/PAL.
120	CE006E-120	98
125	CE006E-125	98
130	CE006E-130	98
140	CE006E-140	98
150	CE006E-150	98
160	CE006E-160	85
180	CE006E-180	54
200	CE006E-200	48

Koljeno dvodijelno 45° / Elbow 2-part 45° / Zweiteiliger Rauchrohrbogen, 45°

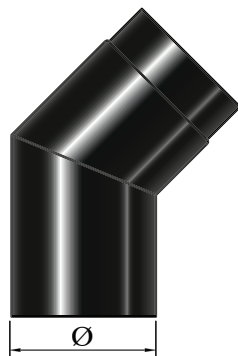

Ø [mm]	BROJ ARTIKLA ART. NR. CODE	KOM./PAL. PCS./PAL. STÜCK/PAL.
120	CE008E-120	128
125	CE008E-125	128
130	CE008E-130	128
140	CE008E-140	112
150	CE008E-150	112
160	CE008E-160	96
180	CE008E-180	72
200	CE008E-200	54

S koljeno / S Elbow / S Bogen

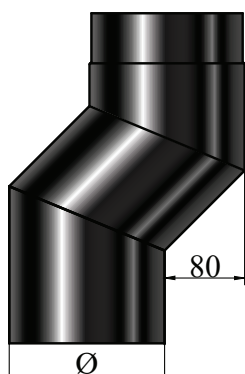



Ø [mm]	BROJ ARTIKLA ART. NR. CODE	KOM./PAL. PCS./PAL. STÜCK/PAL.
100	CE110E-100	175
120	CE110E-120	98
125	CE110E-125	98
130	CE110E-130	98
140	CE110E-140	98
150	CE110E-150	98
160	CE110E-160	72
180	CE110E-180	72
200	CE131E-200	54

1,20 mm Čelični lim / Steel sheet / Stahlblech

 Boje: crna, smeđa i bijela / Color: black, brown and white / Farbe: schwarz, braun und weiß

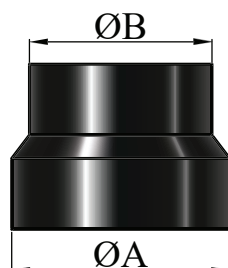
Redukcija / Decreasing adapter / Reduktion



ØA-ØB [mm]	BROJ ARTIKLA ART. NR. CODE	 KOM./PAL. PCS./PAL. STÜCK/PAL.
150/120	CE013E-001	280
140/120	CE013E-002	280
140/130	CE013E-003	280
180/150	CE013E-004	240
200/150	CE013E-005	165
200/160	CE013E-006	165
200/180	CE013E-007	165
130/120	CE013E-008	280
150/130	CE013E-009	280
160/150	CE013E-010	240
180/160	CE013E-011	240
150/140	CE013E-012	280
250/200	CE013E-024	85
120/100	CE013E-025	280
160/130	CE013E-026	240
160/120	CE013E-027	240
220/200	CE013E-031	

Cijev sa zasunom / Flue pipe with damper / Rauchrohr mit Drosselklappe

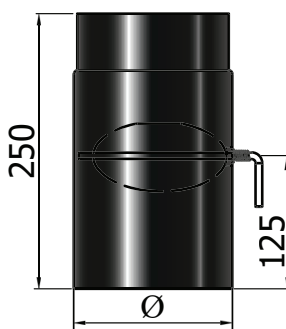

Ø [mm]	BROJ ARTIKLA ART. NR. CODE	 KOM./PAL. PCS./PAL. STÜCK/PAL.
120	CE034E-120	288
125	CE034E-125	288
130	CE034E-130	288
150	CE034E-150	210
160	CE034E-160	180
180	CE034E-180	162
200	CE034E-200	120

Zaobljeno koljeno 90° (2mm) / 90° 'full form' bend (2mm) / Rauchrohrbogen, gezogen, 90° (2mm)



BROJ ARTIKLA
ART. NR.
CODE

CE018E-150

1,20 mm Čelični lim / Steel sheet / Stahlblech

● ● ○ Boje: crna, smeđa i bijela / Color: black, brown and white / Farbe: schwarz, braun und weiß

▶ T komad s poklopcem / Tee with cover / T stück mit Deckel

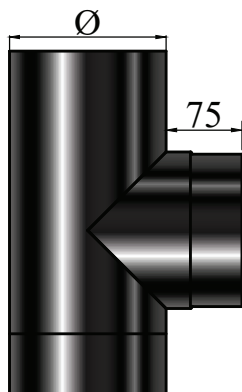

Ø [mm]	BROJ ARTIKLA ART. NR. CODE	KOM./PAL. PCS./PAL. STÜCK/PAL.
120	CE131E-120	162
125	CE131E-125	98
130	CE131E-130	98
140	CE131E-140	98
150	CE131E-150	98
160	CE131E-160	72
180	CE131E-180	72
200	CE131E-200	48

▶ Cijev s otvorom / Flue pipe with door / Rauchrohr mit Reinigungsöffnung

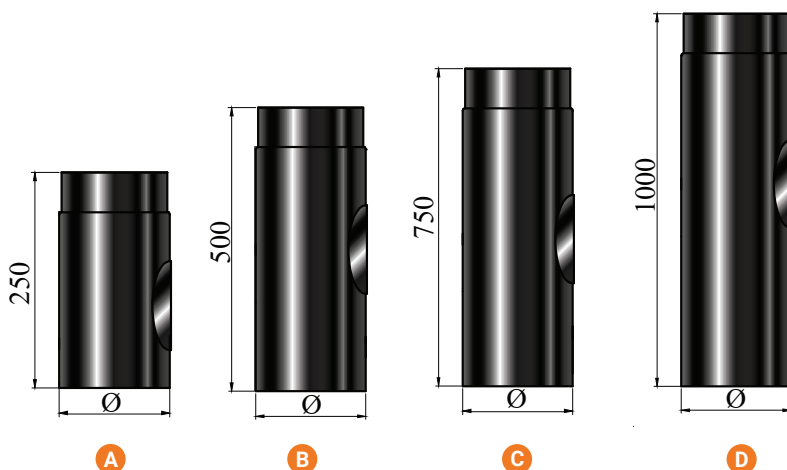

A 250

Ø [mm]	BROJ ARTIKLA ART. NR. CODE	KOM./PAL. PCS./PAL. STÜCK/PAL.
100	CE140E-100	360
120	CE140E-120	280
125	CE140E-125	280
130	CE140E-130	280
140	CE140E-140	220
150	CE140E-150	220
160	CE140E-160	180
180	CE140E-180	170
200	CE140E-200	130

B 500

Ø [mm]	BROJ ARTIKLA ART. NR. CODE	KOM./PAL. PCS./PAL. STÜCK/PAL.
100	CE135E-100	170
120	CE135E-120	130
125	CE135E-125	130
130	CE135E-130	130
140	CE135E-140	114
150	CE135E-150	114
160	CE135E-160	80
180	CE135E-180	80
200	CE135E-200	60

C 750

Ø [mm]	BROJ ARTIKLA ART. NR. CODE	KOM./PAL. PCS./PAL. STÜCK/PAL.
100	CE142E-100	100
120	CE142E-120	77
125	CE142E-125	77
130	CE142E-130	77
140	CE142E-140	77
150	CE142E-150	77
160	CE142E-160	77
180	CE142E-180	50
200	CE142E-200	35

D 1000

Ø [mm]	BROJ ARTIKLA ART. NR. CODE	KOM./PAL. PCS./PAL. STÜCK/PAL.
100	CE141E-100	80
120	CE141E-120	70
125	CE141E-125	70
130	CE141E-130	70
140	CE141E-140	60
150	CE141E-150	60
160	CE141E-160	44
180	CE141E-180	40
200	CE141E-200	27

TELESKOP CIJEV 500x1,2mm emajlirana
 TELESKOP RAUCHROHR 500x1,2 mm emailliert
 TELESCOPE FLUEPIPE 500x1,2 mm enamel

Cijev 130x1,2 mm s kondenz. prstenom emajlirana
 Rauchrohr 130x1,2 mm m. Kond. Ring emailliert
 Fluepipe 130x1,2 mm with condensate ring enamel

	Ø [mm]	Broj artikla Art.Nr. Code	kom./pal. stück/pal. pcs./pal.		Ø [mm]	Broj artikla Art.Nr. Code	kom./pal. stück/pal. pcs./pal.
	120	CE101E-120	144		120	CE046E-120	480
	125	CE101E-125	144		130	CE046E-130	480
	130	CE101E-130	144		140	CE046E-140	300
	140	CE101E-140	114		150	CE046E-150	300
	150	CE101E-150	114		160	CE046E-160	250
	160	CE101E-160	80		180	CE046E-180	250
	180	CE101E-180	80		200	CE046E-200	150
	200	CE101E-200	56				

Cijev 750x1,2 mm s kondenz. prstenom emajlirana
 Rauchrohr 750x1,2 mm m. Kond. Ring emailliert
 Fluepipe 750x1,2 mm with condensate ring enamel

	Ø [mm]	Broj artikla Art.Nr. Code	kom./pal. stück/pal. pcs./pal.
	120	CE126E-120	80
	130	CE126E-130	80
	140	CE126E-140	80
	150	CE126E-150	80
	160	CE126E-160	80
	180	CE126E-180	50
	200	CE126E-200	30