



HR

Nemate dimnjak ili vam ne odgovara mjesto na kojem se nalazi vaš dimnjak? Naši fasadni dimnjaci od nehrđajućeg čelika predstavljaju brzo i jednostavno rješenje ovih problema.

Namijenjen je za vanjsku ugradnju zbog korozijske otpornosti i povećane otpornosti na nastajanje kondenzata. Sastavlja se u segmentima. Maksimalni razmak između glavnih nosivih oslonaca iznosi 30 m, a oni se učvršćuju držačima na međusobnoj udaljenosti do 4 metra. Toplinska otpornost je do 600 °C.

ENG

You don't have a chimney or the location of your chimney is unsuitable? Our stainless steel façade chimneys provide a fast and simple solution to the problem.

The chimney is intended for outdoor installation because of its corrosion resistance and increased resistance to condensate formation.

It is assembled in segments. The maximum distance between the main bearing supports is 30 m. They are fastened by brackets placed at a distance of up to 4 meters. It is resistant to heat from 600 °C.

DE

Sie haben keinen Schornstein? Die Lage des Schornsteins entspricht nicht Ihren Wünschen? Unsere Fassaden-Schornsteine aus Edelstahl sind eine schnelle und einfache Lösung für diese Probleme.

Sie sind aufgrund ihrer Korrosionsbeständigkeit und der erhöhten Kondensationsbeständigkeit für den Ausseneinsatz vorgesehen. Sie werden aus Segmenten zusammengestellt und durch Halterungen mit einem Zwischenabstand von 4 m befestigt wobei der Maximalabstand zwischen den tragenden Hauptstützen 30 m beträgt. Ihre Wärmebeständigkeit ist bis zu einer Temperatur von 600°C gegeben.



**Troslojni dimnjaci od
nehrđajućeg čelika s 30 mm
toplinske izolacije**

**Three-wall stainless steel
flue pipes with 30mm thermal
insulation**

**Dreischichtige
Edelstahlrauchrohre mit 30mm
Wärmedämmung**

Cijev od nehrđajućeg čelika s izolacijom /
Stainless steel pipe with insulation / Rauchrohrelement mit Dämmung

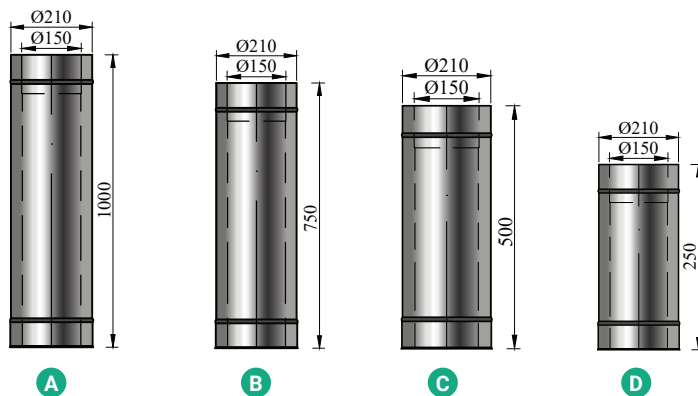

A		B	
Ø150x1000		Ø150x750	
BROJ ARTIKLA ART. NR. CODE	KOM./PAL. PCS./PAL. STÜCK/PAL.	BROJ ARTIKLA ART. NR. CODE	KOM./PAL. PCS./PAL. STÜCK/PAL.
CEX10-150	24	CEX11-150	33
C		D	
Ø150x500		Ø150x250	
BROJ ARTIKLA ART. NR. CODE	KOM./PAL. PCS./PAL. STÜCK/PAL.	BROJ ARTIKLA ART. NR. CODE	KOM./PAL. PCS./PAL. STÜCK/PAL.
CEX12-150	50	CEX13-150	90

Konusni vrh dimnjaka s izolacijom / Stainless steel flue line nose cone
with insulation / Schornsteinmündung, konisch mit Dämmung

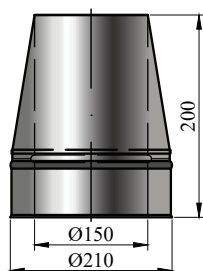

Ø150	
BROJ ARTIKLA ART. NR. CODE	KOM./PAL. PCS./PAL. STÜCK/PAL.
CEX14-150	50

T komad s izolacijom / Stainless steel tee with insulation / Feuerungs-
anschluss (T Stück)

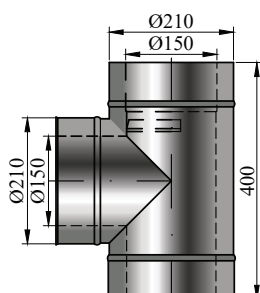

Ø150	
BROJ ARTIKLA ART. NR. CODE	KOM./PAL. PCS./PAL. STÜCK/PAL.
CEX16-150	90

Okapnica / Rain cowl / Regenhaube

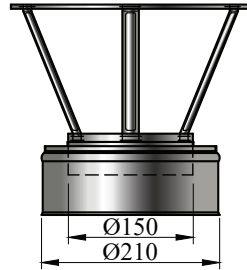

Ø150	
BROJ ARTIKLA ART. NR. CODE	KOM./PAL. PCS./PAL. STÜCK/PAL.
CEX15-150	50

Koljeno s izolacijom / Insulated stainless steel elbow /
Rauchrohrbogen mit Dämmung

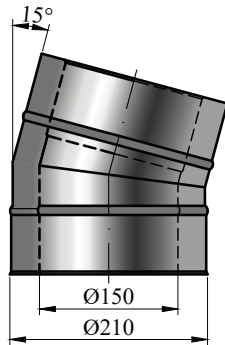

A

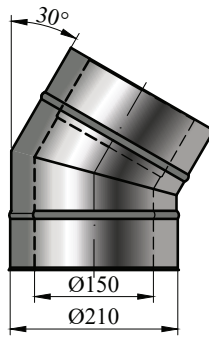

B

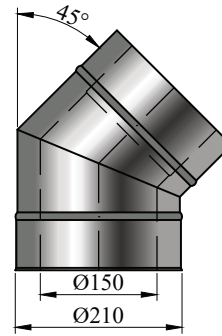

C

A Ø150/15°		B Ø150/30°		C Ø150/45°	
BROJ ARTIKLA ART. NR. CODE	KOM./PAL. PCS./PAL. STÜCK/PAL.	BROJ ARTIKLA ART. NR. CODE	KOM./PAL. PCS./PAL. STÜCK/PAL.	BROJ ARTIKLA ART. NR. CODE	KOM./PAL. PCS./PAL. STÜCK/PAL.
CEX16-150	90	CEX17-150	90	CEX18-150	90

Vrata dimnjaka / Stainless steel chimney door /
Schornsteintür Edelstahl

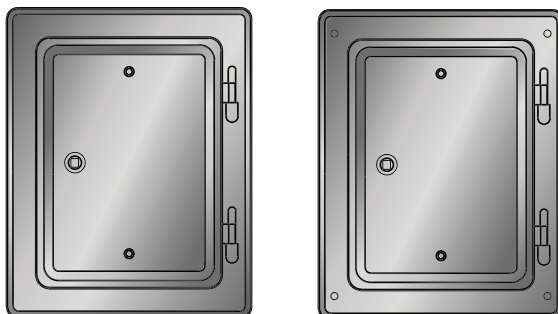

120 x 200
BROJ ARTIKLA / ART. NR. / CODE
CEX07-001
120 x 180
BROJ ARTIKLA / ART. NR. / CODE
CEX07-002

Element za pregled i čišćenje / Stainless inspection and cleaning element with insulation / Rauchrohrelement mit Dämmung und Reinigungsöffnung

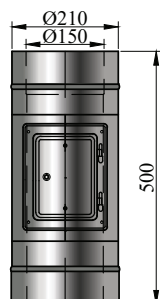

Ø150	
BROJ ARTIKLA ART. NR. CODE	KOM./PAL. PCS./PAL. STÜCK/PAL.
CEX20-150	45

Osnovni komad s ispustom za kondenzat / Base plate with condensate drain / Grundplatte mit Kondensatablauf

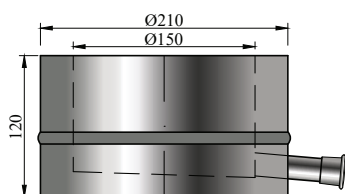

Ø150	
BROJ ARTIKLA ART. NR. CODE	KOM./PAL. PCS./PAL. STÜCK/PAL.
CEX21-150	132

Set podesivog konzolnog nosača / Wall support set, adjustable / Wandkonsolenset, verstellbar

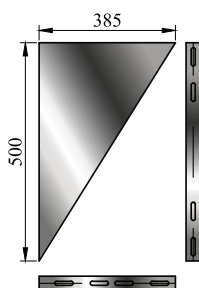

50-150 mm	
BROJ ARTIKLA ART. NR. CODE	KOM./PAL. PCS./PAL. STÜCK/PAL.
CEX22-150	276

Podesivi zidni držač s obujmicom / Adjustable wall support with clamp / Wandabstandshalter, verstellbar

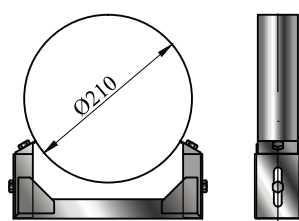

50-100 mm	
BROJ ARTIKLA ART. NR. CODE	KOM./PAL. PCS./PAL. STÜCK/PAL.
CEX23-150	240

► Obujmica / Clamp / Rohrschelle

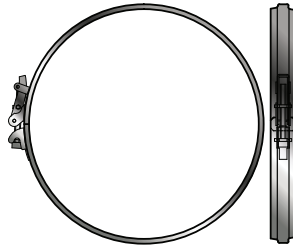

Ø210	
BROJ ARTIKLA ART. NR. CODE	KOM./PAL. PCS./PAL. STÜCK/PAL.
CEX24-150	480

► Rozeta / Rosette collar / Rosette

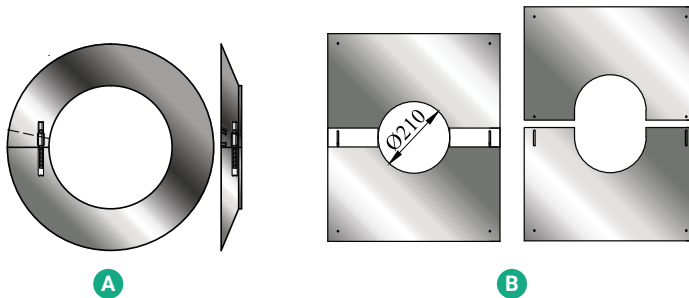

A Ø210 Podesiva rozeta / Rosette / Wandblende	
BROJ ARTIKLA ART. NR. CODE	KOM./PAL. PCS./PAL. STÜCK/PAL.
CEX25-150	200
B Ø150 Dvodijelna rozeta / Two part / Wand-und Deckenblende	
BROJ ARTIKLA / ART. NR. / CODE	
CEX27-150	

► Cijevna zaštita dvostruka / Twin wall sleeve / Übergangsstück

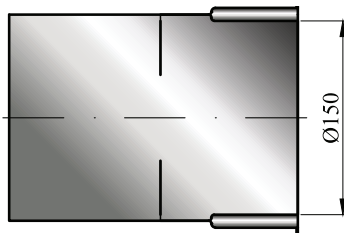

Ø150x200 mm	
BROJ ARTIKLA ART. NR. CODE	KOM./PAL. PCS./PAL. STÜCK/PAL.
CEX26-150	180

► Prijelaz dvostijenski/jednostijenski / Stainless steel twin/single wall decreasing adapter / Übergangsstück, doppelwandig zu einwandig

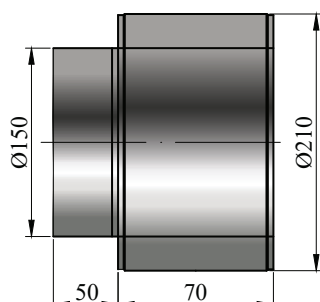

Ø150	
BROJ ARTIKLA ART. NR. CODE	KOM./PAL. PCS./PAL. STÜCK/PAL.
CEX28-150	150